

FireAngel SPECIFICATION

WTSL-SN-1 Alarm Control Unit with Wi-Safe 2[®]
Installation and User Guide

For use with Wi-Safe 2 Smoke, Heat and Carbon Monoxide Alarms

Wi-Safe[®] 2

PLEASE READ THIS GUIDE IN FULL BEFORE USING YOUR WTSL-SN-1 ALARM CONTROL UNIT!

This user guide is also available in large text and other formats.
Please call **0800 171 2009** for further information.

Battery powered Alarm Control Unit with Test, Silence, Locate function. Non-replaceable 3V DC battery.

W2 module contained within WTSL-SN-1 independently tested to RF standard EN 301 489-1 V1.9.2, EN 301 489-3 V1.6.1, EN 300 220-2 V3.1.1

Frequency: 868MHz

With the present declaration, Sprue Safety Products Ltd confirms that the WTSL-SN-1 conforms to the essential requirements and other relevant measures of the 2014/53/EU Directive.

The Declaration of Conformity can be accessed on the website: <http://spru.es/EC-WTSL-SN-1>



Email: **specification@fireangeltech.com** / Web: **www.fireangel.co.uk**
Technical Support Line: **0800 171 2009**

Sprue Safety Products Ltd. Vanguard Centre, Coventry CV4 7EZ UK

INSTALLATION GUIDE



Features	4
Positioning	6
Installation.	6
Wireless Interlink	8
Making the Alarm Control Unit Tamper Proof	10

USER GUIDE

Testing the Alarm System	12
Product Functionality	13
Reorganising a Network	16
When an Alarm Sounds	17
LED Indicators.	18
Troubleshooting.	20
Maintenance.	22
Disposal	23
Warranty.	23

INSTALLATION GUIDE

FEATURES

- Wi-Safe 2[®] technology, enabling wireless interlinking between other Wi-Safe 2 products.
- Test / Silence (TEST / ) button, allowing you to regularly test all wirelessly interlinked alarms on a network. Pressing the silence button will reduce the sensitivity of alarms for up to 10 minutes, unless carbon monoxide has been detected, in which case you can use the 'Locate' function below to find the source alarm.
- Locate button (), allowing you to silence all alarms but the initiating alarm, during an alarm condition. During a fault condition, this feature will allow you to locate the alarm in fault, in a similar way.
- Alarm memory function - allows you to investigate previous alarm events.
- 10 year sealed for life battery.
- 5 year warranty.

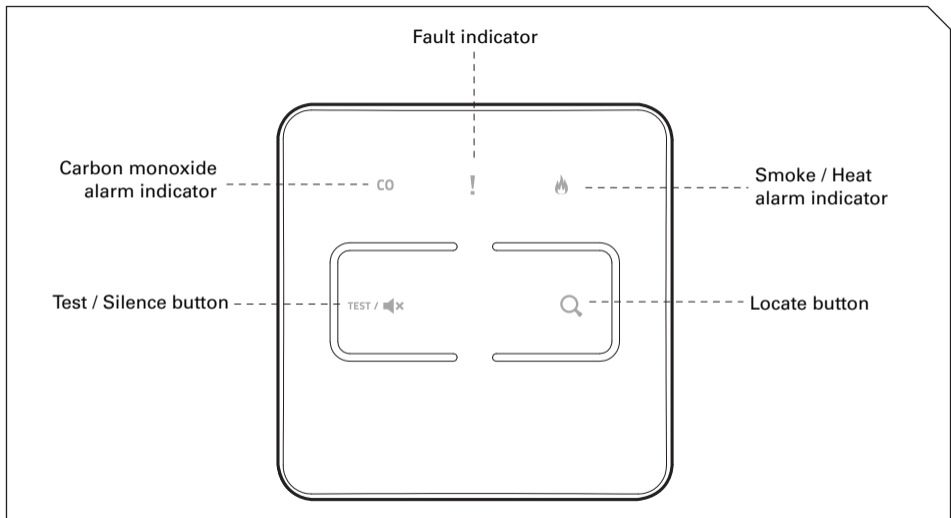

POSITIONING

This Alarm Control Unit is suitable for use in domestic premises only. It should be installed at an accessible point on the wall, in a location where it will not be accidentally operated or knocked.

INSTALLATION

- Ensure this Alarm Control Unit is installed by a competent person who feels able to install it according to the instructions.
- Read all installation instructions prior to installing this product.

WARNING: To prevent injury, this Alarm Control Unit must be securely attached to the wall in accordance with the installation instructions.

To mount the bracket onto a wall:

Please ensure that you use the screws provided, as they were chosen specifically for use with this product. Drill holes into the wall and insert supplied wall plugs. Screw the bracket in place.

ACTIVATING THE ALARM CONTROL UNIT

The Alarm Control Unit has a sealed-in non-replaceable battery. To activate the control unit remove the disabling tab.

Upon activating the control unit all three LED's should simultaneously flash twice, to indicate that they are working.

Once the alarm is activated it can then be learnt into a Wi-Safe 2 network, before securing to the wall bracket.

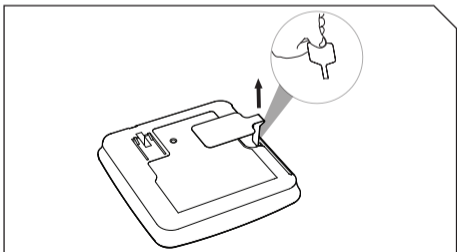
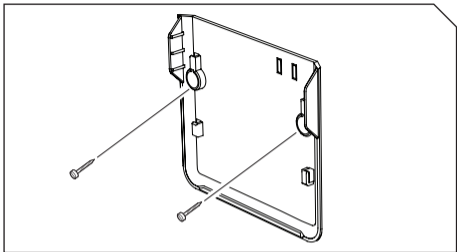

WIRELESS INTERLINK

The Alarm Control Unit is designed to be used as a remote interface on a network of up to 49 products within the Wi-Safe 2 range. The Alarm Control Unit can be used to test, silence or locate any alarms on the Wi-Safe 2 network. It is not designed to communicate with wireless alarms from other ranges or manufacturers. The control unit needs to be 'learned-in' or interlinked, in order to communicate within the network.

Wi-Safe2 enables wireless communication with any other product with Wi-Safe2 technology inside. When one alarm detects smoke / heat / carbon monoxide, the wireless module inside sends a signal to all the connected alarms, ensuring almost instantaneous reaction across the network.

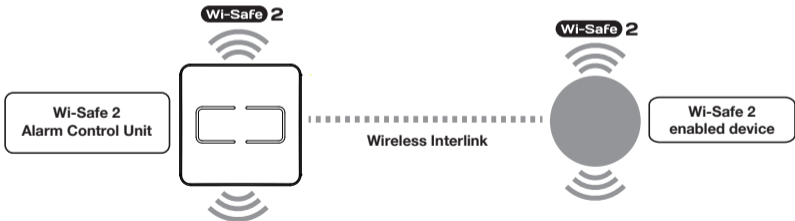

HOW TO 'LEARN-IN' THE ALARM CONTROL UNIT TO A WI-SAFE 2 NETWORK:

1. Using a ballpoint pen, briefly push and release the 'learn button' on the back of the control unit. The red LED next to the learn button will flash briefly then light up for approximately 5 seconds.
2. During these 5 seconds you need to briefly press the test button on an alarm already in the network, to wirelessly interlink the two. The alarm will sound its audible test pattern.
3. The red LED on the back of the control unit will flash to indicate that it has been 'learned-in' successfully. If the test button is not pressed quickly enough, the 'learn-in' process will fail. If this happens, repeat the process.

Your Alarm Control Unit counts as one unit within the network. If it is installed retrospectively, then the existing network cannot exceed 49 units in size.

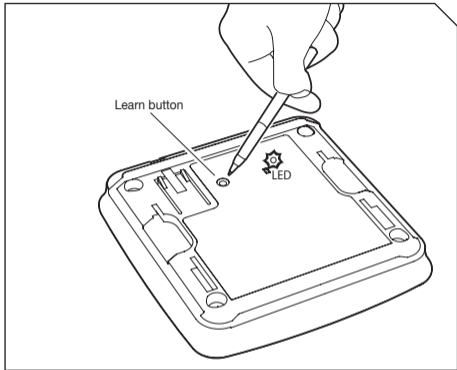

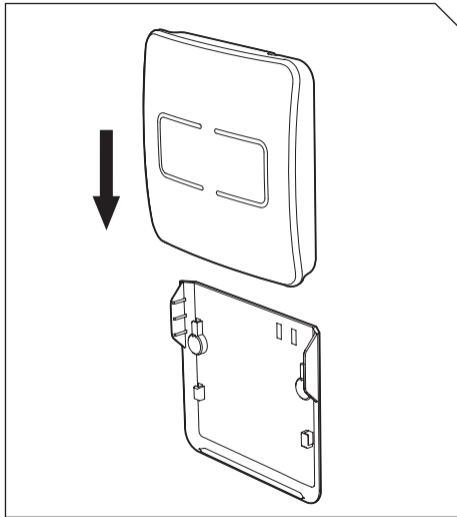

4. To complete the installation simply slide the control unit onto the bracket. The control unit is now part of the whole network.

The method above assumes you have already installed your alarm network, prior to installing your Alarm Control Unit. If you want to install your Alarm Control Unit first, you can learn your smoke, heat and CO alarm into it by following the instructions in your alarm manual, using the Alarm Control Unit as alarm 1.

MAKING THE ALARM CONTROL UNIT TAMPER PROOF

Do not complete this action until you have wirelessly interlinked all of your alarms.

The Alarm Control Unit is provided with an anti-tamper feature, ensuring, where needed it cannot be removed from the wall.

To make use of this feature you will need to push out the two blanking plates on the top right-hand side of the bracket, using a small screwdriver, being careful to support the bracket fully whilst doing so.

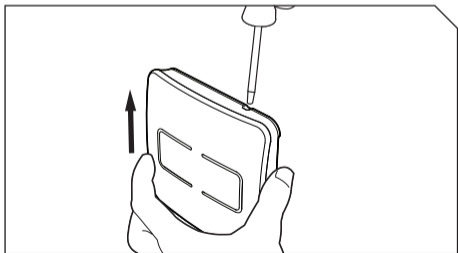
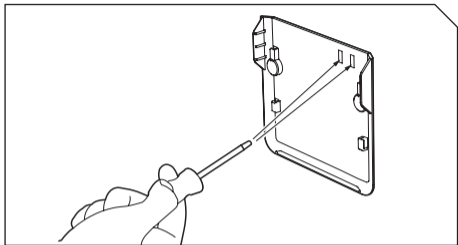

Once the rest of the installation is complete, and the control unit is fixed to the bracket it can only be removed using the following method:

Insert a small screwdriver into the hole on the top right-hand corner of the control unit, until it stops, this will disengage the lock, then gently ease the control unit up to release it from the bracket.

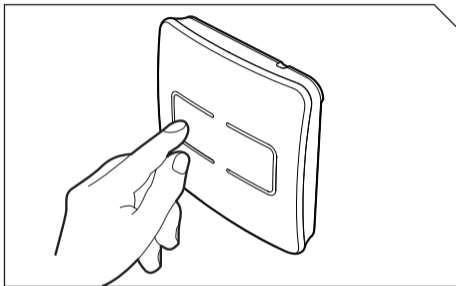







TESTING THE ALARM SYSTEM

Press the Test / Silence (TEST / ) button to confirm that the control unit is operating properly. This will instigate a three minute test. All networked alarms should sound. To stop the test (earlier than 3 minutes), simply press the Test / Silence (TEST / ) button again. This test should be performed on a weekly basis.

Pressing the Test button on the Alarm Control Unit creates a lot of RF traffic. If you need to use the feature more than once, please wait for 5 minutes to let the network settle down.

PRODUCT FUNCTIONALITY

Function	Description
TEST /  Test / Silence button	<p>Test button: This allows you to test all wirelessly interlinked alarms from one centralised location.</p> <p>Silence button: This will silence all wirelessly interlinked smoke and heat alarms and reduce the system sensitivity for up to 10 minutes.</p>
 Locate button	In an alarm event this will silence all wirelessly interlinked alarms except the initiating alarm which has sensed carbon monoxide / smoke.
 Smoke / heat alarm indicator	This indicates that a smoke / heat alarm has been activated.
 Carbon monoxide indicator	This indicates that a carbon monoxide alarm has been activated.
 Fault indicator	This indicates a fault with the control unit or one of the alarms within the network.

LOCATE BUTTON

If the alarms are sounding and an alarm indicator is flashing, but there's no obvious hazard, pressing the 'Locate' button (🔍) will silence all wirelessly interlinked alarms except for the initiating alarm which has sensed smoke / heat or carbon monoxide. Within two minutes the system will return to normal operation and the alarms will continue to sound if smoke / heat or carbon monoxide is still present. To make locating the alarm easier, the control unit can be removed from its bracket and carried around the property (providing the tamper proof function has not been engaged), allowing you to press the 'Locate' or 'Test' button whilst moving from room to room.

SILENCE BUTTON

If the alarms are sounding and the smoke / heat alarm indicator is flashing, but there's no obvious hazard, pressing the 'Silence' button (🔊) will silence all wirelessly interlinked alarms and reduce the system sensitivity for up to 10 minutes. However if excessive smoke is sensed the silence function will be overridden. The indicator will continue to flash unless the smoke disappears. **Please Note:** An alarm cannot be silenced using the Alarm Control Unit if carbon monoxide has been detected, however the 'Locate' function will allow you to find out which of the CO alarms is the initiating alarm.

ALARM MEMORY

If one of the alarm indicators is flashing every 10 seconds this indicates that a smoke alarm, heat alarm or carbon monoxide alarm has previously been activated. Pressing the 'Locate' button (🔍) will clear the LEDs and sound the source alarm so you can investigate this further. You

can press the 'Locate' button () repeatedly until the source alarm is identified (fully compatible with the FireAngel Specification Wi-Safe 2 smoke, heat and CO alarms). **Please Note:** Only the most recent alarm event will be visible. If both a CO and smoke / heat alarm have previously been activated, both LED's will show but the CO alarm will always take precedence, and this is the alarm which will sound. **Never ignore an alarm.** If there is evidence of an alarm event, be sure to investigate further.

FAULT DETECTION

If the amber fault LED and a red alarm LED are flashing this indicates that an alarm on the network has developed a fault. To identify the faulty alarm press the 'Locate' button. If the alarm in fault sounds a unique 'SOS' sound pattern continue to '**A**' below. If no SOS sound pattern is heard proceed to '**B**' below.

- A.** In case you need to locate the unit again, please wait for 2 minutes before trying to locate for the SOS pattern. Take down the alarm which is sounding. Unlearn the alarm from the network using a ball point pen in the circular 'learn-in' hole in the back of the alarm. Briefly push and release and then push and hold the 'learn-in' button. The red LED will remain illuminated during this process. When the red LED goes out, release the button, it will then flash twice, followed by three further flashes to illustrate that the alarm has successfully been 'un-learnt' from the network. Reorganise the network as detailed on the next page. The LEDs indicating a fault should now have stopped flashing and the faulty alarm can now be replaced with a new alarm if required.

- B.** Check all alarms are on their base plate and activated. If all alarms are activated, clear the fault by pressing the locate button twice.

REORGANISING A NETWORK

If you have un-learnt and replaced or removed any alarms, you can 'reorganise' in order to optimise the network performance. To do this you will need to press and hold the 'Locate' button for 5 seconds. The Alarm Control Unit will then enter 'Reorganisation Mode', during which time you will see a series of flashes from the LEDs. The time taken for this process to complete will depend on the number of units in the network.

If successful, once the reorganisation is complete, the Control Unit should return to standby mode, with no LEDs flashing.

If the reorganisation is not successful, and LEDs are still flashing (all 3 LED's flash together (CO + ! + 🔥) 3 times, then a fourth flash (CO + 🔥 only) occurs, repeatedly), you will need to exit 'Reorganisation Mode'. To do this hold the 'Locate' button for 5 seconds, wait for 5 minutes and then repeat the process above.

Prior to performing network reorganisation, test the network by pressing the test button on one of the randomly selected units and ensure that all units chirp / flash in response. This is essential to make sure that all the units are communicating with each other and ensures network reorganisation does

not delete wanted units. In case one of the working units is out of range for networking, please check the installation position of the units and adjust / install an additional unit to help with the routing of messages.

WHEN AN ALARM SOUNDS

Never ignore an alarm.

If there is a fire evacuate the premises and call the fire brigade. If the source of the alarm is not immediately apparent check which indicator is flashing on the control unit.

If the CO indicator is flashing:

- Keep calm and open the doors and windows to ventilate the property.
- Stop using all fuel-burning appliances and ensure, if possible, that they are turned off.
- Evacuate the property leaving the doors and windows open.
- Ring your gas or other fuel supplier on their emergency number; keep the number in a prominent place.

LED INDICATORS

Red CO LED	Red Smoke / Heat LED	Amber Fault LED	Status	Action required
Flashing for 10 seconds, every hour	Flashing for 10 seconds, every hour	Flashing for 10 seconds, every hour	The Alarm Control Unit is not part of a network.	Please refer to the 'Wireless Interlink' section to 'learn-in' the control unit to the network.
Flashing rapidly every second			Alarm: A carbon monoxide leak has been detected.	Keep calm and open the doors and windows to ventilate the property.
	Flashing rapidly every second		Alarm: Smoke / heat has been detected.	Keep calm and evacuate the property.
Either the carbon monoxide indicator or the smoke / heat indicator or both, are flashing every 10 seconds			This indicates that one of the alarms has previously been activated.	Please refer to the 'Locate' section of this manual.
Either the carbon monoxide indicator or the smoke / heat indicator or both, are flashing		Double flashing every second	An alarm on the network has developed a fault.	Please refer to the 'Fault Detection' section of this manual.

Red CO LED	Red Smoke / Heat LED	Amber Fault LED	Status	Action required
<p>All 3 LED's flash together (CO + ! + 🔥) 3 times, then a fourth flash (CO + 🔥 only) occurs. This flash pattern is repeated.</p>			<p>This indicates that the 'Reorganisation Mode' has been unsuccessful.</p>	<p>To exit 'Reorganisation Mode' hold the 'Locate' button for 5 seconds, wait a couple of minutes and then press and hold the 'Locate' button for 5 seconds to start 'Reorganisation Mode' again.</p>
		<p>Flashing once every 5 seconds</p>	<p>Low battery condition or the end of the product life.</p>	<p>The control unit should be replaced as soon as possible.</p>
		<p>Flashing rapidly</p>	<p>This indicates an internal fatal radio failure.</p>	<p>Please contact Technical Support on: 0800 171 2009 or specification@fireangeltech.com.</p>

TROUBLESHOOTING

Issue	Indication
No lights come on when I press any of the buttons on the Alarm Control Unit	This may indicate that the control unit has not been successfully activated, see section 'Activating the Alarm Control Unit'. If the unit still fails to activate please contact Technical Support via email: specification@fireangeltech.com or by calling: 0800 171 2009 .
When pressing the test button nothing is happening	This indicates that the control unit has not been successfully activated, see section 'Activating the Alarm Control Unit'.
Unable to remove the control unit from its bracket	You need to disengage the locking pins. Refer to the 'Making the Alarm Control Unit Tamper proof' section.
If you have any questions about the operation of your Alarm Control Unit, please visit the FireAngel website for FAQs: www.fireangel.co.uk alternatively contact Technical Support via email: specification@fireangeltech.com or by calling: 0800 171 2009 .	

WTSL Compatibility Chart

Function	WST-630 (Prior to 2014 Models)	WST-630 (2014 Model onwards)	WHT-630	W2-CO-10X	WSM-SN-1	WHM-SN-1
Test		✓	✓	✓	✓	✓
Silence	✓	✓	✓		✓	✓
Alarm Memory			✓	✓	✓	✓
Locate	✓	✓	✓	✓	✓	✓
Locate (SOS Fault Finding)	✓	✓	✓	✓	✓	✓
Re-organisation	✓	✓	✓	✓	✓	✓

MAINTENANCE

This Alarm Control Unit will act as a remote interface between the alarms in your home when maintained properly. To ensure the reliability of the control unit:

- Keep the control unit free from dust by gently vacuuming the case with a soft brush attachment every 3 months.
- Never use cleaning solutions on the control unit. Simply wipe with a damp cloth.
- Do not paint the control unit.
- Do not spray aerosols on or near the control unit.
- Do not use any solvent based products near the control unit.
- Do not attempt to repair the control unit.
- Do not attempt to change the battery.

- Do not remove any screws or open the main casing of the control unit. Any attempt to do so may cause malfunction and will invalidate the warranty.

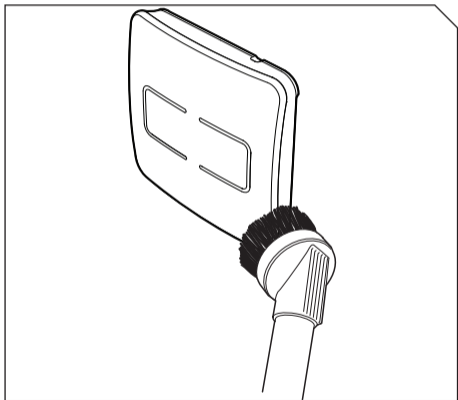

DISPOSAL

Waste electrical products should not be disposed of with your other household waste. The Alarm Control Unit is ideally suited for disposal within the waste electronic and electrical equipment (WEEE) recycling scheme. Please recycle where facilities exist. Check with your local authority, retailer or contact our Technical Support team for recycling / disposal advice, as regional variations apply.

WARNING: Do not burn or dispose of in fire.

WARNING: If your Alarm Control Unit is dropped or damaged, as a precaution, it should be removed from the building and you should contact Technical Support on **0800 171 2009** or **specification@fireangeltech.com**.

WARRANTY

Sprue Safety Products Ltd warrants to the original purchaser that the enclosed WTSL-SN-1 Alarm Control Unit be free from defects in materials and workmanship under normal residential use and service for a period of five years from the date of purchase. Provided product is sent back to Sprue Safety Products Ltd with proof and date of purchase, Sprue Safety Products Ltd hereby warrants that during the five year period commencing from the date of purchase Sprue Safety Products Ltd, at its discretion, agrees to replace the unit free of charge. The warranty on any replacement WTSL-SN-1 Alarm Control Unit, will last for the remainder of the period of the original warranty in respect of the unit originally purchased – that is from the date of original purchase and not from the date of receipt of the replacement product. Sprue Safety Products Ltd reserves the right to offer an alternative product similar to that being replaced if the original model is no longer available or in stock. This warranty applies to the original retail purchaser from the date of original retail purchase and is not transferable. Proof of purchase is required. This warranty does not cover damage resulting from accident, misuse, disassembly, abuse or lack of reasonable care of the product, or applications not in accordance with the user guide. It does not cover events and conditions outside of Sprue Safety Products Ltd's control, such as Acts of God (fire, severe weather etc.). It does not apply to retail stores, service centres or any distributors or agents. Sprue Safety Products Ltd will not recognise any changes to this warranty by third parties.

Sprue Safety Products Ltd shall not be liable for any incidental or consequential damages caused by the breach of any expressed or implied warranty. Except to the extent prohibited by applicable law, any implied warranty of merchantability or fitness for a particular purpose is limited in duration for five years. This warranty does not affect your statutory rights. Except for death or personal injury, Sprue Safety Products Ltd shall not be liable for any loss of use, damage, cost or expense relating to this product or for any indirect or consequential loss, damages or costs incurred by you or any other user of this product.



Carbon Monoxide Alarm
Wireless: W2-CO-10XT



Heat Alarm
Wireless: WHM-SN-1
Non-Wireless: HM-SN-1



Smoke Alarm
Wireless: WSM-SN-1
Non-Wireless: SM-SN-1



Alarm Control Unit
Wireless: WTSL-SN-1

Wi-Safe[®] 2 technology included in all wireless products