

User Manual

FireAngel[®]

Smoke Alarm

THERMOPTEK[®]

Model
ST-625

 14
0333-CPR-292075
Smoke alarm devices
0333 EN 14604:2005 + AC:2008
DOP: SADOPST-625-01

ST-625
GN3054R1



A Sprue Safety Products Brand

Sprue Safety Products Ltd.

Vanguard Centre, Sir William Lyons Road, Coventry CV4 7EZ UK

Technical Support: **0800 141 2561** / UK Textphone users dial: **18001 0800 141 2561**

EIRE dial: **1-800 523171** / Email: **technicalsupport@sprue.com** / Web: **www.fireangel.co.uk**

CONTENTS

Introduction	4	Alarm Smart Silence™	10
Sensor technology	4	Sleep Easy™	11
Application	5	Maintenance.	12
How to install your smoke alarm	6	Troubleshooting.	13
Operation	8	Disposal	15
Battery replacement	8	Warranty.	15
Alarm test	9		

Note: This user manual is also available in large text and other formats. Please email: **technicalsupport@sprue.com** or call **0800 141 2561** for further information.

INTRODUCTION

Congratulations! You've made a wise investment in protecting your family and home. The ST-625 multi-criteria high performance detector is the ultimate alternative to traditional alarms. Groundbreaking Thermoptek® technology combines the very latest in optical sensing with thermal enhancement, providing a faster response to both fire types eliminating the need for ionisation sources which can be harmful to the environment. In addition, this smoke alarm allows the low battery warning chirp to be silenced until it is convenient to replace the batteries (recommended within 7 days). The Sprue Safety Products range is constantly being improved and expanded. Please visit www.fireangel.co.uk to find out about the latest additions to our range of innovative products.

IMPORTANT: This user manual contains important information regarding the operation of your FireAngel® smoke alarm. Ensure you read this user manual fully before installing and operating the alarm. If you are installing this smoke alarm for use by others, you must leave this manual (or a copy of it) with the end user.

SENSOR TECHNOLOGY

The ST-625 combines an optical sensing chamber with thermal enhancement. The alarm is effective at detecting slow burning fires, and constant monitoring of temperature changes enables the sensitivity of the alarm to be instantly increased thereby quickening the typical response time to fast flaming fires significantly.

Thermoptek® alarms are “toast-proof” meaning they can be positioned in areas close to kitchens that may be affected by cooking fumes. Heat alarms should be used in kitchens where required.

The state of the art thermally-enhanced optical sensing chamber provides a fast reaction to both slow smouldering and fast flaming fires in a single alarm. The Thermoptek® technology constantly monitors temperature changes and if a rate of temperature rise is detected the sensitivity of the alarm is increased meaning it has a fast response time to fast flaming fires as well as slow smouldering fires.



APPLICATION

WARNING: Your FireAngel® smoke alarm can be installed into a new build property as additional protection to an existing smoke detection system only. It cannot be used as a substitute for a hard wired system as required in new build properties. In this type of property the building regulations require alarms to be interlinked. You can obtain further information from your local fire service or building control department at your local council offices. These sources generally provide advice on new builds or projects that require planning permission. Your smoke alarm typically meets the minimum requirements for family living units in existing buildings, as long as at least one unit is installed on each floor/level of your property. In order to achieve the earliest fire warning, we recommend that a smoke alarm is fitted in all rooms where the temperature is normally between 4°C (40°F) and 38°C (100°F).

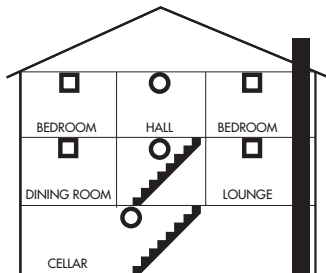
WARNING: The alarm positions shown are based on typical homes. Construction and layout of individual dwellings will vary, so this should be regarded only as a guide. Check with your local fire station for further guidance.



EXISTING HOMES

-  MINIMUM RECOMMENDATIONS
-  RECOMMENDED FOR ADDITIONAL PROTECTION

NOTE: Kitchens should be covered by a self contained heat detector.

Multi-family or mixed occupant residence

(Tenancy building, student accommodation)

Your FireAngel® smoke alarm can also be used in individual flats and bedsits, providing the same conditions are met as for a single-family residence. However, there must already be a primary fire detection system that meets regulatory requirements for common areas such as lobbies and hallways.

Institutions and Hotels

This includes motels, hospitals, day care facilities, long-term health care facilities,

boarding houses and dormitories. Your ST-625 smoke alarm can be used in individual sleeping/resident rooms, providing the same conditions are met as for a single-family residence. However, there must already be a primary fire detection system that meets regulatory requirements for common areas such as lobbies and hallways. Use of the ST-625 smoke alarm in common areas may not provide sufficient fire warning to residents or meet regulatory requirements.

Mobile Homes and Caravans

This smoke alarm is suitable for use in mobile homes and caravans.

Commercial and Industrial Premises

This smoke alarm is not intended for any non-residential, commercial or industrial application, nor for any other purpose than described above.

HOW TO INSTALL YOUR SMOKE ALARM

IMPORTANT: Make sure you have read and understood this manual before installing your smoke alarm.

1. Install Batteries

IMPORTANT: Before fitting your smoke alarm, the batteries must be installed. Remove the protective wrapper from the batteries.

Insert the batteries provided into the battery aperture on the back of the smoke

alarm as shown, making sure that the positive and negative connections are in the correct position.

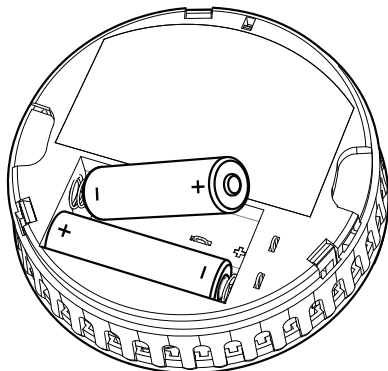

The red LED on the front of the alarm will soon start flashing once every 40 seconds to show that the alarm is activated.

Caution: The horn is designed to be very loud in order to wake you. Once the batteries are installed, the test button on the front of the alarm will be active. Avoid placing the alarm close to your ear when installing the batteries in case you press the test button.

2. Fitting the Base Plate

Prior to fitting the base plate to the ceiling or wall ensure you refer to 'Application' (see page 5) to ensure that the smoke alarm is installed in the correct location in your home.

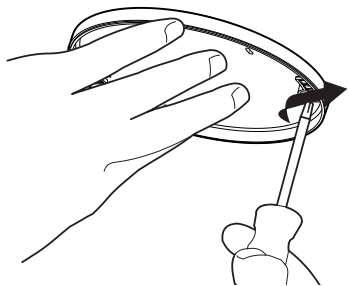
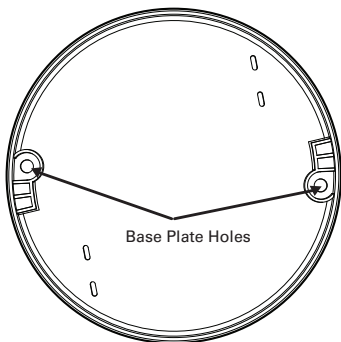

- 3. Fit Your FireAngel® Smoke Alarm**
Hold the alarm up to the base plate and push and rotate the alarm clockwise into position as shown. Make sure that the unit is securely fitted.

The base plate should be attached to the ceiling or wall using the screws and fixings provided. Use the fixing holes on the base plate as a guide when marking the position of the drill holes. With an appropriately sized drill, drill the holes and insert the plastic fixing anchors supplied (if needed).

Fit the base plate to the ceiling or wall using the screws provided.

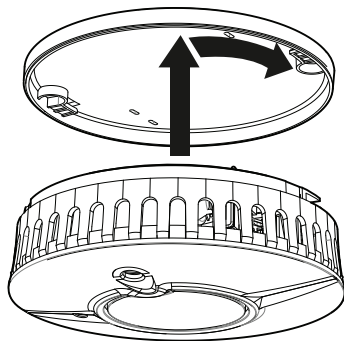

4. Test Your FireAngel® Smoke Alarm

After fitting your alarm to the base plate, wait for 5 seconds for the alarm to settle then test the alarm. See 'Alarm Test'.

OPERATION

Normal condition

The red LED on the front should flash every 40 seconds to show that the alarm is active.

Low Battery Condition

Should your FireAngel® smoke alarm enter a low battery condition, the unit will emit an audible 'chirp' once every 40 seconds. When this occurs, we recommend you replace the batteries immediately. Your FireAngel® smoke alarm will continue to warn of this low battery condition for at least 7 days, however, failure to change the batteries after this time will mean your smoke alarm may have insufficient power to alert you in a real fire situation. When the batteries are removed the battery warning chirp should stop.

Sleep Easy™ - Low Battery Warning Silence

This feature can temporarily silence the low battery chirp for 8 hours which is particularly useful if the warning begins during the night. This feature may be repeated up to 10 times, but is not a substitute for replacing the smoke alarm batteries (see page 11).

BATTERY REPLACEMENT

IMPORTANT: Only the following batteries can be used for replacement. Use of a battery other than those recommended below may have a detrimental effect on the alarm's operation.

Alkaline type:

Energizer E91

Duracell MN1500bB

Panasonic ProPower LR6

Remove the alarm from its base plate by turning anti-clockwise and pulling gently.

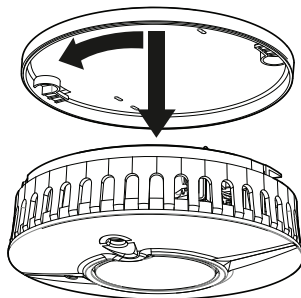

Remove the existing batteries and replace with new batteries from the list of recommended batteries making sure that the positive and negative connections are in the correct position.

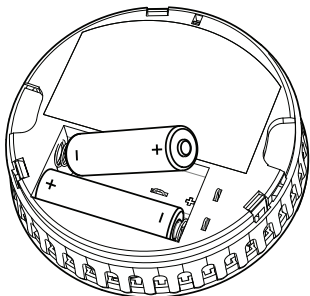

Hold the alarm up to the base plate and push and rotate the alarm clockwise into position as shown. Make sure that the unit is securely fitted.

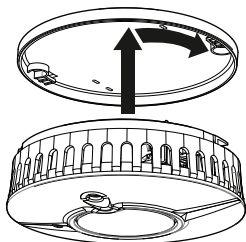

After fitting your alarm to the base plate, wait for 5 seconds for the alarm to settle then test the alarm.

ALARM TEST

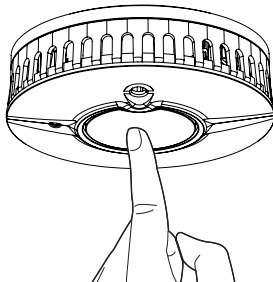

The alarm should be attached to the base plate and tested in its installed position.

Firmly press the test button in the centre and release.

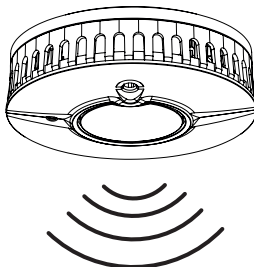

The unit will give an audible alarm consisting of 2 cycles of 3 loud beeps, then stop automatically.

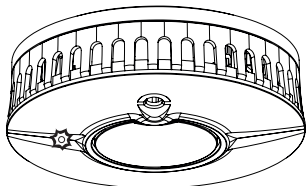

The red LED on your alarm will flash rapidly during the audible signal.

NOTE: The test button accurately tests the alarm's smoke sensing circuit, there is no need to test your alarm with smoke. If your smoke alarm fails to give an audible test signal, please refer immediately to the 'Troubleshooting' section (see page 13).

WARNING: You should test your smoke alarm every week.

ALARM SMART SILENCE™

DANGER: If your FireAngel® smoke alarm emits the full alarm signal and you are not testing the unit, the smoke alarm is warning you of a potentially dangerous situation that requires your immediate attention. Only use the alarm silence function after making sure that there is no fire. Do not block the vents on the alarm

or disable the smoke alarm in any way, as this will remove your protection. Smoke alarms can sometimes react to cooking fumes or other non-emergency situations.

Your smoke alarm features "Smart Silence™" technology. In the event of a known false alarm your smoke alarm can be temporarily silenced by briefly pressing the central test button. Your alarm will automatically return to full sensitivity within 10 minutes.

NOTE: If the level of smoke reaching the alarm is very high the alarm silence will be overridden and the alarm will continue to sound.

Briefly press and release the test button. The alarm sound will soon stop.

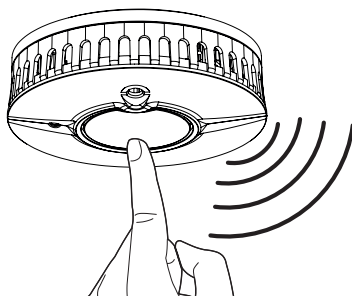

Your alarm will silence and enter into a reduced sensitivity mode for approximately 10 minutes.

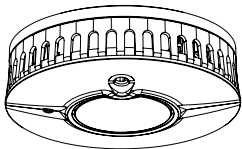

During the reduced sensitivity mode the red LED on your alarm will continue to flash more rapidly than normal, approximately once every 10 seconds.

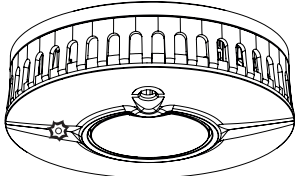

Your alarm will automatically return to full sensitivity on completion of the reset cycle and the red LED will revert to flashing once every 40 seconds.

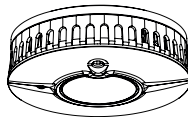

DANGER: Never ignore any alarm. Ignoring the alarm may result in injury or death. If your smoke alarm activates and you are not absolutely certain of the source of the smoke, get everyone out of the house immediately.

SLEEP EASY™

Low battery warnings often start at night or when it may be inconvenient to replace the batteries. You can silence the audible chirp for a period of 8 hours by pressing the test button. Your FireAngel® smoke alarm will still detect smoke during this time of low battery warning silence. However it is recommended that you replace your batteries immediately, and certainly within 7 days, as your FireAngel® alarm may then have insufficient power to warn you of a real fire situation after this time.

WARNING: Your FireAngel® smoke alarm cannot be silenced if the chirp is indicating a fault. In this instance, the unit should be replaced immediately to ensure protection in the event of a fire.

MAINTENANCE

Your FireAngel® smoke alarm has been designed to be as maintenance-free as possible, however there are several things you must do to keep it working properly.

CAUTION: Your FireAngel® smoke alarm is a sealed electrical device and no attempt should be made to open the case. Attempting to open the case will invalidate your warranty.

Testing

Test your smoke alarm once every week, see 'Alarm Test'.

Cleaning

As a minimum your smoke alarm should be cleaned once every 3 months using your vacuum cleaner fitted with the soft brush attachment.

WARNING: Your FireAngel® smoke alarm may false alarm when it is being cleaned using a vacuum cleaner.

IMPORTANT: Do not use solvents or cleaners on your FireAngel® smoke alarm, as they may cause damage to the sensor or circuitry. The unit can be wiped with a slightly damp cloth.

CAUTION: Do not paint the smoke alarm as this may block the openings and prevent smoke from entering the sensor.

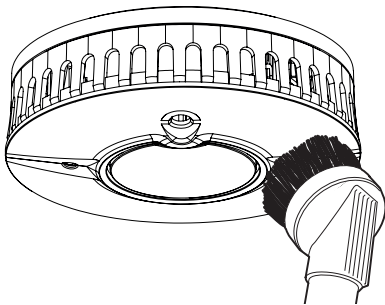

TROUBLESHOOTING

Problem	Solution
Your FireAngel® smoke alarm does not sound during testing	<ul style="list-style-type: none">• If testing immediately after first activating the alarm or replacing the batteries, you should allow a few seconds for the alarm to settle before testing.• Make sure you push the centre of the test button firmly.• If the unit has been silenced and is in low sensitivity mode it may not test. Wait 15 minutes then try again.• If the alarm has been recently fitted and it still fails to self test then contact Technical Support on: 0800 141 2561 or e-mail: technicalsupport@sprue.com.
Your FireAngel® smoke alarm chirps intermittently	<ul style="list-style-type: none">• Check the location of your smoke alarm (see 'Application').• Check that your smoke alarm is definitely the source of chirping; make sure the noise isn't coming from another alarm by process of elimination.• If in doubt, contact Technical Support on: 0800 141 2561 or e-mail: technicalsupport@sprue.com.
Your FireAngel® smoke alarm activates when no smoke is visible	<ul style="list-style-type: none">• Check the location of your smoke alarm (see 'Application').• Clean the smoke alarm (see 'Maintenance').

Problem**Solution**

<p>The low battery warning silence chirp does not silence when the test button is pressed</p>	<ul style="list-style-type: none">• You can only silence the low battery warning chirp for a maximum of 10 times. Replace batteries. If the batteries have been recently fitted, and the alarm is still chirping, contact Technical Support.• If the red LED flashes at a separate time from the chirp, a fault is indicated.• If within warranty contact Technical Support (see below). Otherwise replace immediately.
<p>You experience frequent unwanted alarms</p>	<ul style="list-style-type: none">• Check the location of your FireAngel® smoke alarm (see 'Application').• Clean the smoke alarm (see 'Maintenance').• If the frequent unwanted alarms continue contact Technical Support for advice.
<p>If you have any questions about the operation of your alarm, please contact Technical Support between 9am - 5pm Monday – Friday. Telephone: 0800 141 2561 or e-mail: technicalsupport@sprue.com.</p>	

DISPOSAL



Waste electrical products should not be disposed of with your other household waste. Unlike ionisation smoke alarms, which have been in the UK since 1987, your Thermoptek® alarm does not contain any radioactive material. This means that

the alarm is ideally suited for disposal within the waste electronic and electrical equipment (WEEE) recycling scheme.

Please recycle where facilities exist. Check with your local authority, retailer or contact our technical support team for recycling/disposal advice as regional variations apply.

Once the batteries are removed, the low battery warning chirp will stop. The batteries should always be removed before disposal.

WARNING: Do not attempt to open.

WARNING: Do not burn or dispose of in fire.

WARNING: If your smoke alarm is dropped or damaged, as a precaution, it should be removed from the building and you should contact FireAngel® Technical Support on 0800 141 2561 or technicalsupport@sprue.com.

WARRANTY

Sprue Safety Products Ltd warrants to the original purchaser that its enclosed smoke alarm be free from defects in materials and workmanship under normal residential use and service for a period of 2 (two) years from the date of purchase. Provided it is returned with postage prepaid and proof of purchase date, Sprue Safety Products Ltd hereby warrants that during the 2 (two) year period commencing from the date of purchase Sprue Safety Products Ltd, at its discretion, agrees to replace the unit free of charge. The warranty on any replacement ST-625 alarm, will last for the remainder of the period of the original warranty in respect of the alarm originally purchased – that is from the date of original purchase and not from the date of receipt of the replacement product.

Sprue Safety Products Ltd reserves the right to offer an alternative product similar to that being replaced if the original model is no longer available or in stock. This warranty applies to the original retail purchaser from the date of original retail purchase and is not transferable. Proof of purchase is required.

This warranty does not cover damage resulting from accident, misuse, disassembly, abuse or lack of reasonable care of the product, or applications not in accordance with the user manual. It does not cover events and conditions outside of Sprue Safety Products Ltd's control, such as Acts of God (fire, severe weather etc.). It does not apply to retail stores, service centres or any distributors or agents. Sprue Safety Products Ltd will not recognise any changes to this warranty by third parties.

Sprue Safety Products Ltd shall not be liable for any incidental or consequential damages caused by the breach of any expressed or implied warranty. Except to the extent prohibited by applicable law, any implied warranty of merchantability or fitness for a particular purpose is limited in duration for 2 (two) years.

This warranty does not affect your statutory rights. Except for death or personal injury, Sprue Safety Products Ltd shall not be liable for any loss of use, damage, cost or expense relating to this product or for any indirect, or consequential loss, damages or costs incurred by you or any other user of this product.

